









Sable 430-445W

High efficiency monofacial modules



TOPCon 182mm

• **TOPCon MODULE ADVANTAGE**

-  Multi-Busbar technology
-  Superior load capacity
-  High module efficiency
-  Excellent low-light performance
-  Lower annual attenuation
Longer warranty
-  Low BOS and LCOE
-  Reduce hot spot effect
-  Higher bifaciality

• **QUALITY SYSTEM**

ISO9001 / ISO14001 / ISO45001

• **PRODUCT CERTIFICATION**



• **INSURANCE**

PICC

• **WARRANTY**

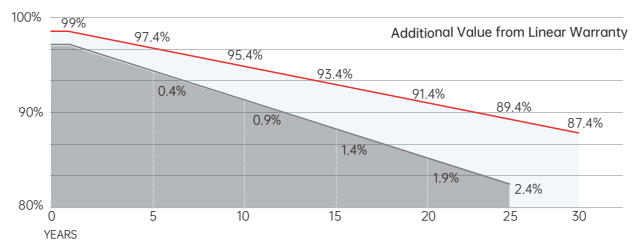

15 YEARS Guarantee on product material and workmanship

30 YEARS Linear power output warranty



Electrical Characteristics

Module Type	SRP-430-BTD-HV		SRP-435-BTD-HV		SRP-440-BTD-HV		SRP-445-BTD-HV	
	STC	NOCT	STC	NOCT	STC	NOCT	STC	NOCT
Maximum Power at STC (Pmp)	430	324	435	328	440	332	445	336
Open Circuit Voltage (Voc)	38.90	36.96	39.10	37.15	39.30	37.34	39.50	37.53
Short Circuit Current (Isc)	13.99	11.19	14.07	11.26	14.15	11.32	14.23	11.38
Maximum Power Voltage (Vmp)	32.30	30.41	32.50	30.62	32.70	30.82	32.90	31.02
Maximum Power Current (Imp)	13.32	10.66	13.39	10.71	13.47	10.77	13.54	10.83
Module Efficiency at STC(ηm)	22.02		22.28		22.53		22.79	
Power Tolerance(W)	(0, +4.99)							
Maximum System Voltage	1500V DC							
Maximum Series Fuse Rating	25 A							

STC: Irradiance 1000 W/m² module temperature 25°C AM=1.5
Power measurement tolerance: +/-3%

Temperature Characteristics

Pmax Temperature Coefficient	-0.29 %/°C
Voc Temperature Coefficient	-0.25 %/°C
Isc Temperature Coefficient	+0.046 %/°C
Operating Temperature	-40 ~ +85 °C
Nominal Operating Cell Temperature(NOCT)	45±2 °C

Mechanical Specifications

External Dimensions	1722 x 1134 x 30 mm
Weight	21.5 kg
Solar Cells	TOPCon 182 x 91mm (108 pcs)
Front Glass	3.2mm AR coating tempered glass, low iron
Frame	Anodized aluminium alloy
Junction Box	IP68, 3 diodes
Output Cables	4.0mm ² , 250mm(+)/350mm(-) or Customized Length
Mechanical Load	Front side 5400Pa/ Rear side 2400Pa

Packing Configuration

	1722 x 1134 x 30 mm	
Container	20'GP	40'HQ
Pieces per Pallet	40	36
Pallets per Container	6	26
Pieces per Container	240	936

For details, please consult SERAPHIM.

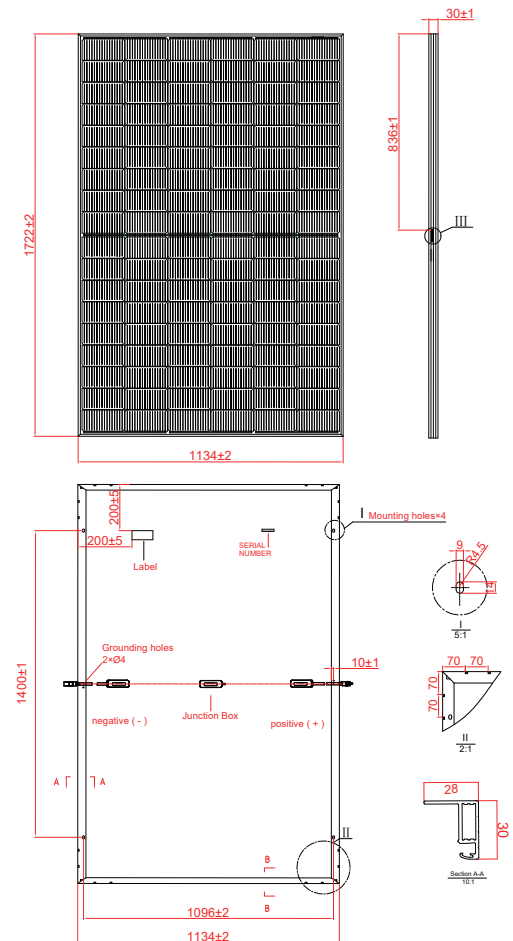

I-V Curve

