

QUICKLY FIELD REPLACEMENT AND UPGRADE

LONG STRINGS



- String length increased by up to 30%
- Fewer BOS components
- Faster installation

- Inverter optimization
- Lower wire-losses
- Plus all the benefits of Optimization

OPTIMIZATION



- Shade and age tolerance
- Enhanced energy yield
- Greater design flexibility

- Maximized roof usage
- Plus all the benefits of Safety

SAFETY



- NEC 2014 690.12 rapid shutdown compliant
- Module-level deactivation
- Automatic or manual shutdown

- Over-temperature protection
- Plus all the benefits of Monitoring

MONITORING



- Reduced O&M costs
- PV-2.0 data synchronization
- Module bar code tracking

- CRM integration
- Warranty tracking
- Fleet management

DIODES



- Similar to a standard junction box
- Standardization on basic TS4 baseplate
- Applicable to conventional and smart modules

- Field replaceable and upgradeable
- Heat dissipation away from the module

This innovative module provides five levels of functionalities. Based on a universal platform, you can select the right functionality for each solar project, which is best for budget and performance.

ENHANCED J-BOX HEAT DISSIPATION CAPABILITY

By incorporating the diodes onto the removable covers of Junction Box, the reliability of module is greatly improved, dissipates less heat on the back sheet.

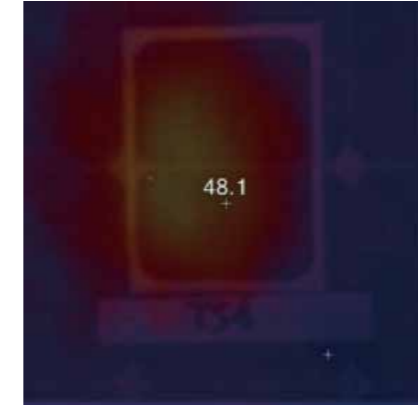

SMART J-BOX

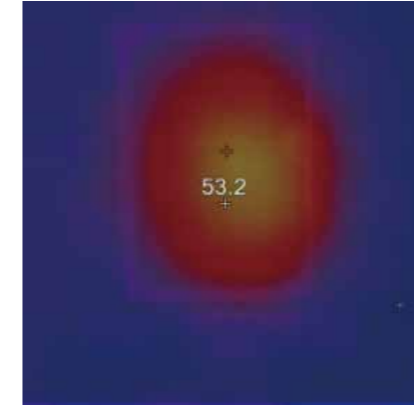

STANDARD J-BOX

FULL COMPATIBILITY AND MULTIFUNCTIONAL SYSTEM

This innovative module is fully compatible with any inverter. The modules are wired together just like standard modules, if you select the modules with monitoring function or higher level functions, they will communicate wirelessly with the gateway. Then, the gateway transmits data wirelessly to the cloud connect which controls the array with the gateway and uploads data to Cloud.

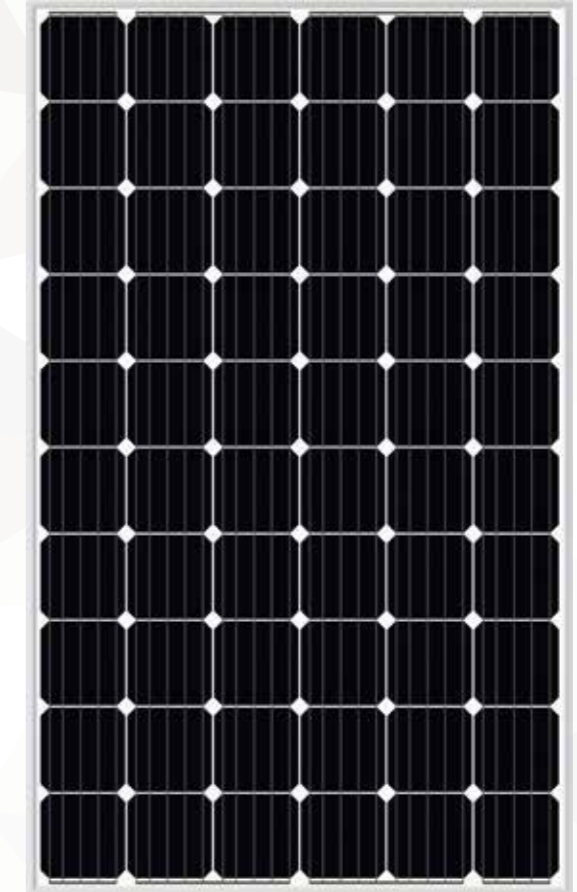
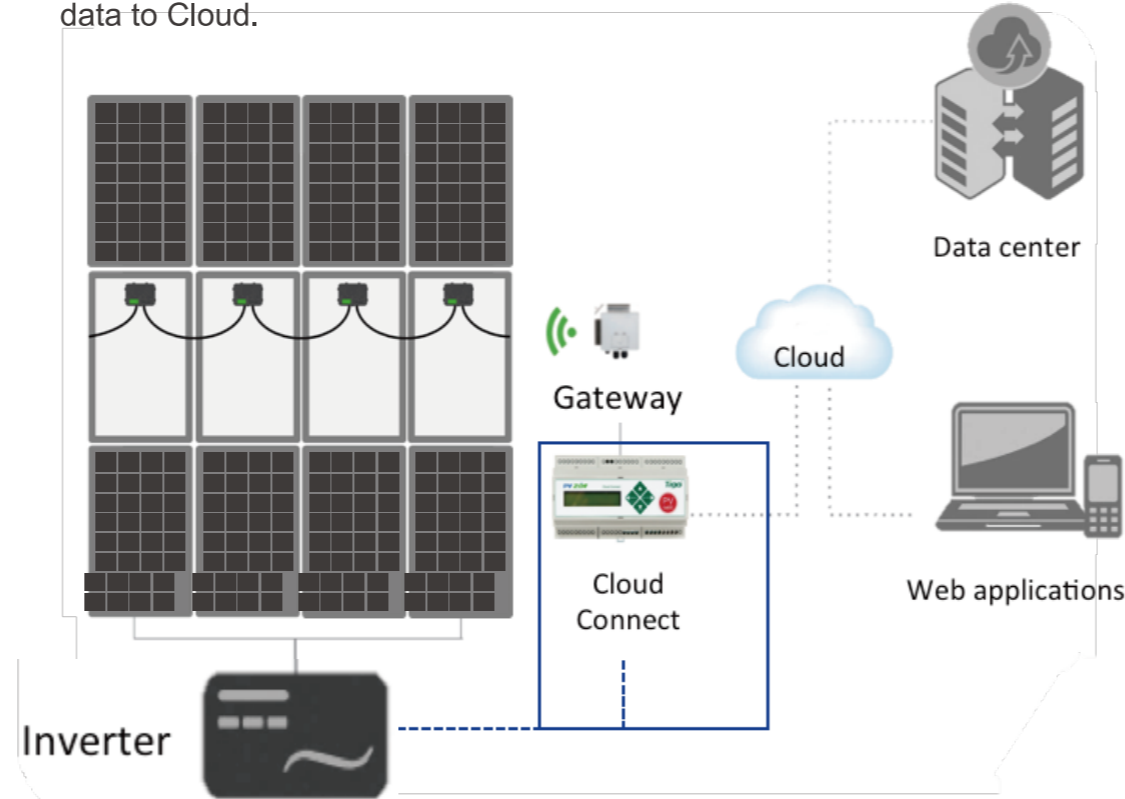

SERAPHIM SMART-Tigo
280-295w



Seraphim delivers your smart energy needs, optimizes your project and ROI. This innovative module integrates a smart platform, which five different covers of Junction Box can fit onto.

SRP-6MB(-HV)



280-295w

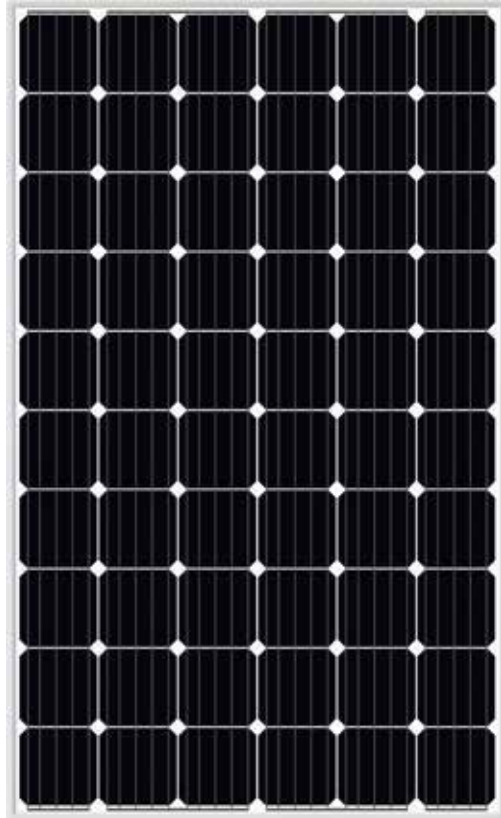

MANAGEMENT SYSTEM

ISO 9001: Quality management system
ISO 14001: Standard for environmental management system
OHSAS 18001: International standard for occupational health and safety assessment system

WARRANTY

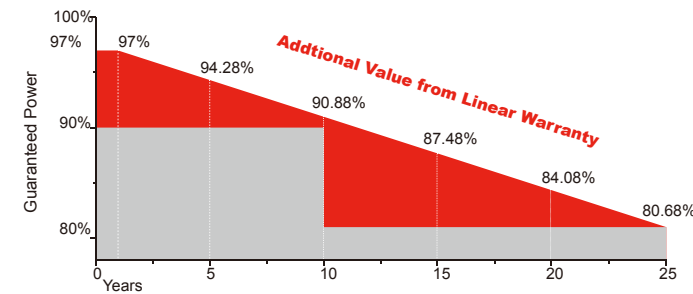

10 YEARS Guarantee on product material and workmanship
25 YEARS Linear power output warranty

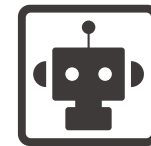

Advanced smart platform



Rapid shutdown



Outstanding power output capability at low irradiance



Quickly field replacement and upgrade



Triple 100% Electroluminescence (EL) tests minimize breakage rate

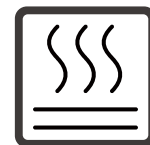

Enhanced J-Box heat dissipation capacity

SRP-6MB(-HV)

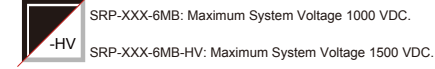

Electrical Characteristics(STC)

Module Type	SRP-280-6MB SRP-280-6MB-HV	SRP-285-6MB SRP-285-6MB-HV	SRP-290-6MB SRP-290-6MB-HV	SRP-295-6MB SRP-295-6MB-HV
Maximum Power at STC -P _{mp} (W)	280	285	290	295
Open Circuit Voltage -V _{oc} (V)	38.9	39.1	39.3	39.5
Short Circuit Current -I _{sc} (A)	9.22	9.33	9.44	9.56
Maximum Power Voltage -V _{mp} (V)	31.3	31.5	31.7	31.9
Maximum Power Current -I _{mp} (A)	8.95	9.05	9.15	9.25
Module Efficiency STC-η _m (%)	17.21/17.11	17.52/17.41	17.83/17.72	18.13/18.02
Power Tolerance (W)	(0,+4.99)			
Maximum System Voltage (V)	1000VDC / 1500 VDC			
Maximum Series Fuse Rating (A)	15A			

Electrical Characteristics(NOCT)

Module Type	SRP-280-6MB SRP-280-6MB-HV	SRP-285-6MB SRP-285-6MB-HV	SRP-290-6MB SRP-290-6MB-HV	SRP-295-6MB SRP-295-6MB-HV
Maximum Power at NOCT -P _{mp} (W)	208	212	215	219
Open Circuit Voltage -V _{oc} (V)	36.0	36.2	36.3	36.5
Short Circuit Current -I _{sc} (A)	7.45	7.54	7.63	7.73
Maximum Power Voltage -V _{mp} (V)	29.7	29.9	30.0	30.1
Maximum Power Current -I _{mp} (A)	7.01	7.09	7.17	7.28

Temperature Characteristics

Pmax Temperature Coefficient	-0.38 %/°C
Voc Temperature Coefficient	-0.28 %/°C
Isc Temperature Coefficient	+0.05 %/°C
Operating Temperature	-40~+85 °C
Nominal Operating Cell Temperature (NOCT)	45±2 °C

Packing Configuration

	1640 x 992 x 35mm/1650 x 992 x 35mm
Container	20' GP / 40' GP
Pieces per Pallet	30 / 30
Pallets per Container	12 / 28
Pieces per Container	360 / 840

Mechanical Specifications

External Dimensions	1640 x 992 x 35 mm/1650 x 992 x 35 mm
Weight	17.5kg/18.0kg
Solar Cells	Mono crystalline 156.75 x 156.75 mm (60pcs)
Front Glass	3.2 mm AR coating tempered glass, low iron
Frame	Anodized aluminium alloy
Junction Box	IP67
Output Cables	4.0 mm ² ,cable length:900 mm
Connector	MC4 Compatible
Mechanical Load	5400Pa

STC: Irradiance 1000 W/m², module temperature 25°C, AM=1.5
 NOCT: Irradiance 800 W/m², ambient temperature 20°C, wind speed :1m/s
 Specifications are subject to change without further notification.



Technical drawing(SRP-XXX-6MB)

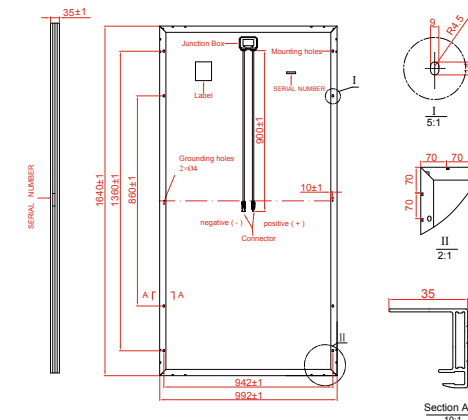

Technical drawing(SRP-XXX-6MB-HV)

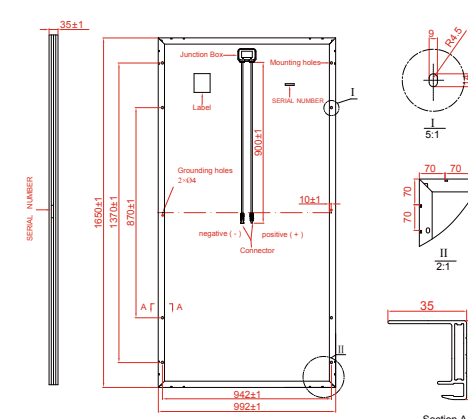

* All Dimensions in mm.
 * The above drawing is a graphical representation of the product.
 For engineering quality drawings please contact SERAPHIM.

I-V Curve

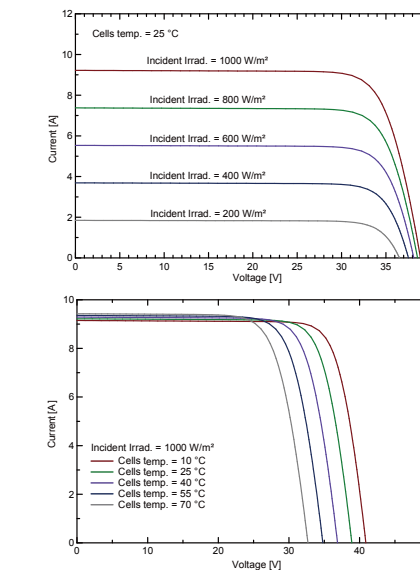

ADVANCED SMART PLATFORM

Seraphim delivers your smart energy needs, optimizes your project and ROI. This innovative module integrates a smart platform, which five different covers of Junction Box can fit onto.

DIODES

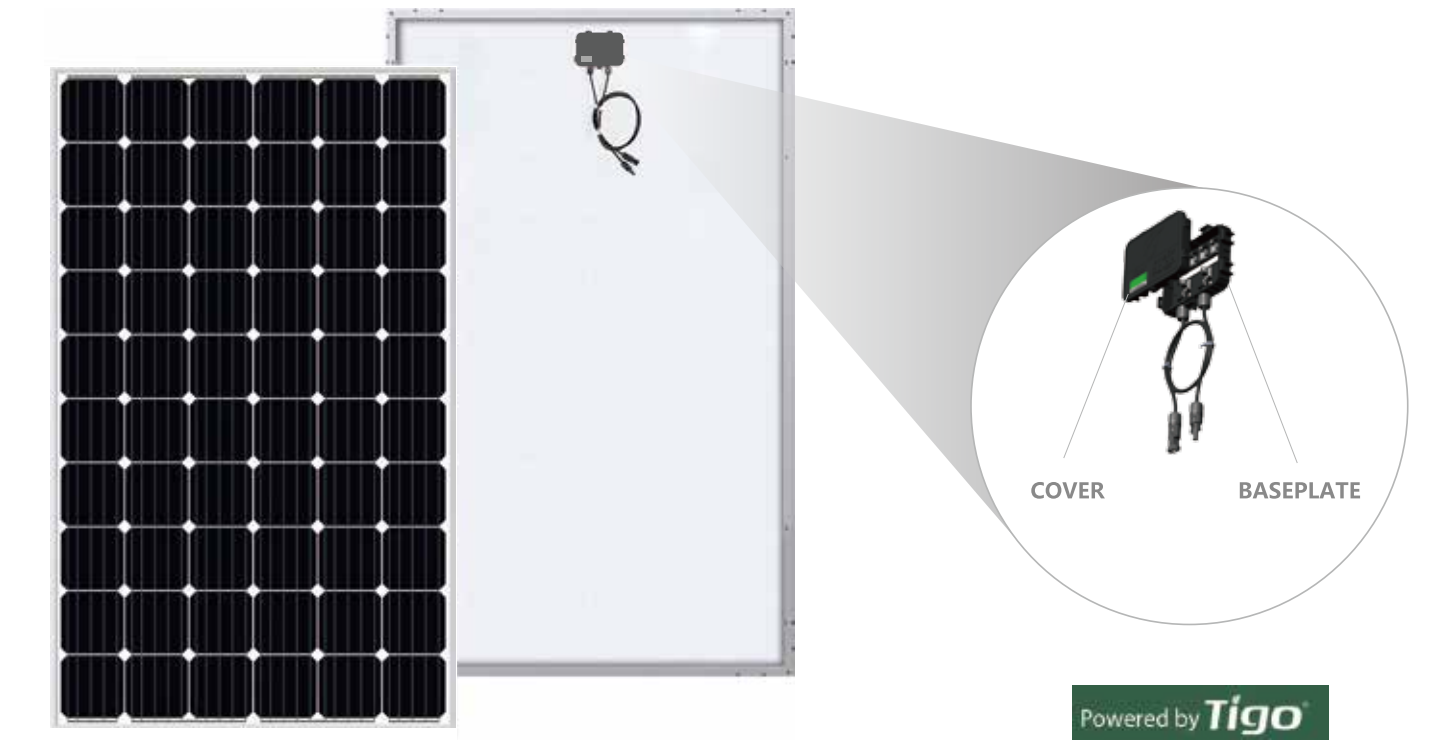

This smart solution gives you perfect user experience and customization, your solar projects can be optimized, monitored or safely protected,etc. Please enjoy Seraphim Smart Solutions!

